

Green Roof Systems

Flat roof solutions



Centre for Agriculture and Bioscience International (CABI)
Oxfordshire

BUILDING BOARD

Roof Size:	2,044m ²
Roofing Systems:	Bauder Thermofol System Bauder Sedum System Biodiverse landscaping finish
Specifier:	Scott Brownrigg
Main Contractor:	Barnwood Construction
Approved Contractor:	Malone Roofing



Bauder is a leading European manufacturer of flat roof waterproofing membranes and insulation to make buildings watertight and thermally efficient; photovoltaic systems for renewable energy generation; green roofs to support the environment and create better living and working spaces for people; and blue roofs for stormwater attenuation and prevention of localised flooding.

Customers choose us because of the way in which we do business, for our robust advice on the right system, and our approach to delivering projects. We work alongside clients to deliver the best solution for a building from our broad portfolio of systems.

Green Roofs

Intentionally grown vegetation on flat roofs to meet environmental, sustainability, and planning objectives

A Bauder green roof combines the finished planting scheme with its supportive components and a secure waterproofing system all covered by a single guarantee.

Green roofs deliver varying levels of benefits to a building, people, the environment, and sustainability. A green roof can be advanced with a solar PV array for renewable energy generation and roof to assist in the prevention of localised flooding top stormwater attenuation.

Specifying a green roof

A green roof is specified for many different reasons encompassing increasing outdoor spaces to enhance the building's use, satisfy planning conditions, meet targets for retaining and supporting biodiversity and net zero, and oppose climate change.

Outline of our green roof systems

- Solutions for new build and refurbishment projects.
- Portfolio of compatible Bauder waterproofing systems.
- Landscaping components to meet the needs of the green roof finish.
- Variety of Bauder extensive vegetation options.
- Comprehensive range of guarantee packages to suit project requirements, including enhancing with a biosolar and blue roof.

Achieving technical objectives

- FLL Guidelines and GRO Code of Best Practice adopted.
- BauderGREEN XF 301 fire tested, classified to BS EN 13505-5.
- Solutions contribute to BREEAM rating assessment.

Enhancements to green roofs

- Biosolar to add an integrated PV array for on-site renewable energy.
- Blue roof for a SuDS solution to attenuate stormwater.



Types of green roofs

- Intensive roof gardens and recreational spaces.
- Biodiverse landscapes to create natural habitats.
- Extensive low maintenance greening of a roof.

Bauder Green Roof Solutions

Systems for new build construction and existing buildings

For all green roofs, an integrated approach is crucial for the design and specification of both the waterproofing and landscaping components to achieve the best results.

Creating a green roof requires key decisions about access and what the roof is to be used for before the design can begin. We will work with you from the earliest design stage to ensure that your green roof project comes to fruition beautifully.

Intensive green roofs

Garden planting schemes require greater depths of substrate and the overall weight of the solution dictates the construction of the supporting structure and the green roof components required to sustain the vegetation. See pages 6-7.

Biodiverse green roofs

The aim is to replicate, as far as is practical, the ecological requirements for the local area. The habitats are designed to support a variety of native plants, birds, animals, and invertebrates. The careful design and construction of these habitats is key to conforming to the local Biodiversity Action Plan (BAP) or the site's Urban Greening Factor (UGF) commitment. See pages 8-9.

Extensive green roofs

Extensive green roofs are constructed using shallow depths of growing mediums and access limited to only allow for maintenance.

A substrate-based green roof will often incorporate a mixed vegetation scheme of low maintenance plants chosen to suit the project and location.

Our BauderGREEN Sedum System is installed with the BauderGREEN XF 301 sedum blanket direct on to our root resistant waterproofing. See pages 10-13.



Enhancing the Roof

Bringing net zero and climate change into focus through further rooftop facilities

Generating renewable energy through adding a PV array and attenuating stormwater with a rooftop SuDS to reduce localised flooding.

Using the roof to generate energy

A flat roof is the ideal place for a solar photovoltaic (PV) installation to generate site-sourced electricity. Our BauderSOLAR G LIGHT is an integrated biosolar solution for mounting photovoltaic renewable energy on a green roof or blue roof where the substrate and vegetation provide the ballasted installation mechanism to secure the array.

A biosolar PV system allows for the entire roof to qualify as a green roof, and if a biodiversity finish is specified this can further enhance the BREEAM credit rating for the roof element. See pages 14-15.

Attenuating rainfall to reduce run-off

A blue roof offers a sustainable drainage method designed to attenuate and slow the discharge of stormwater from a flat roof for up to a 48 hour period via a restrictive flow outlet. Ideal for urban areas where options for ground-based attenuation systems are limited or where construction is being carried out within flood sensitive areas. See pages 16-17.



Bauder Intensive Green Roofs

Outdoor spaces for people to enjoy soft vegetated recreational areas and hard landscaped access zones

Replicating a traditional landscape at roof level with lightweight components and substrates for a shallower build up than conventional landscaping.

Creating an intensive green roof on a building provides additional facilities and maximises the potential of the building.

The desired planting finish will dictate the assembly of the green roof components and the construction of the supporting structure.

Depths of substrate will vary to accommodate trees, shrubs, herbaceous planting, and turfed areas with bedding options for hard landscaping. Maintenance of the roof is required throughout the year to upkeep the landscape and allow the vegetation to flourish.

Plus points

- Assists in maximising the building's potential and overall value of the property.
- Provides valuable recreational space.
- Bauder technical support service gives integrated approach for design and specification of waterproofing and landscaping components.
- Comprehensive range of guarantee packages to fulfil cover requirements for the project (dependent on system/product selection). For more information contact our technical dept for a sample guarantee outlining cover level, terms and conditions.

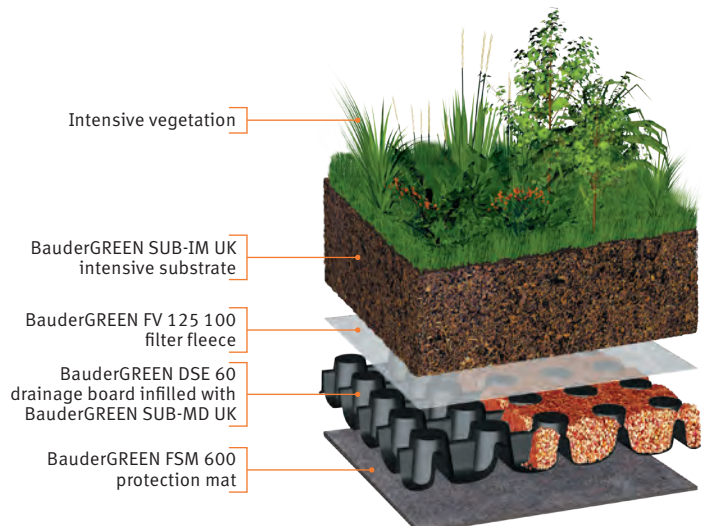

Bauder Intensive Green Roofs



Holyrood Student Accommodation Edinburgh

BUILDING BOARD

Roof Size:	4,000m ²
Roofing Systems:	Bauder Hot Melt System and intensive green roof
Client:	University of Edinburgh
Main Contractor:	Balfour Beatty
Specifier:	Oberlanders Architects & JM Architects
Approved Contractor:	Procladd



All England Lawn Tennis Club Museum Wimbledon

Bauder Biodiverse Green Roofs

Creating a habitat to encourage a wider spread of birds, insects, and plant species

Substrate based non publicly accessed green roofs meeting the requirement for biodiversity at roof level and primarily specified for ecological benefits.

Biodiverse green roofs are generally designed with British native vegetation and additional elements, such as log piles and dew ponds, to create the desired habitat. The different plants are normally established through plugs, seeds, or wildflower blanket on a range of substrate depths, typically 80-150+mm.

Biodiverse green roofs can also be created on a pitch of up to 25 degrees. This configuration requires the BauderGREEN WSP reservoir board to enhance water retention for the plants, hold the substrate in place, and be sufficiently rigid to manage the imposed shear load.

Plus points

- British native vegetation options comprising seed mixes, plug plants, and wildflower blanket.
- Specification embraces all elements of waterproofing, the green roof components and planting scheme.
- Meet Biodiversity Action Plans, Urban Greening Factor, or planning requirements for the location.
- Contributes to BREEAM assessment ratings.
- Single source for design of Bauder waterproofing and green roof with clear accountability.
- Comprehensive range of guarantee packages to fulfil cover requirements for the project (dependent on system/product selection). For more information contact our technical dept for a sample guarantee outlining cover level, terms and conditions.

Biodiverse roof plans

An ecological report will normally define the requirements for the biodiverse finish and our technical team will provide detailed layouts of the roof showing mounding of substrate and location of planting ensuring the loading of the roof is compatible with the structure.

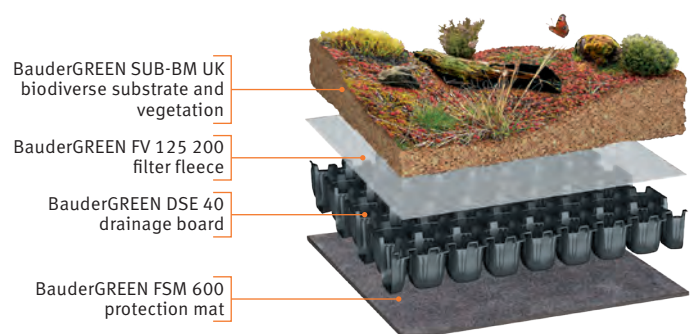

Bauder Biodiverse Green Roofs

Our vegetation options



BauderGREEN WB wildflower blanket for instant coverage at installation

BauderGREEN WB native species wildflower blanket

The UK grown vegetation blanket contains a broad mix of 38 British wildflowers, herbs, and grasses that are included on most BAP lists. The vegetation is grown in lightweight substrate on a coir carrier that is 100% biodegradable. The natural fibres of the coir carrier promote the rapid rooting of the blanket into the BauderGREEN SUB-BM UK biodiverse substrate.

The blanket meets GRO recommendations and the vegetation is specifically selected to flourish in the challenging conditions found at roof top level.



BauderGREEN Plug Plants immediately after planting

BauderGREEN Plug Plants native species wildflowers

The use of small seedling plants allows the specifier to select the individual species to be planted by hand, their position on the roof, and density of planting. The more plugs per square metre, the faster the vegetation will establish to cover the roof entirely.

We supply a large variety of British provenance plug plants to suit the specification and desired finish.



BauderGREEN Flora seed mix established over two years

BauderGREEN Flora Seed Mixes

Our range uses with different blends of seed with British and Scottish provenance to suit different roof environments for coastal, urban, and chalk grassland. They balance the requirement to have grasses and low ground cover, to prevent erosion, with wildflowers to offer a nectar source to many insects visiting the green roof.

Bauder Extensive Green Roofs

Low maintenance, lightweight substrate-based systems with no general access

Extensive green roofs are designed to have thin layers of lightweight substrate growing medium to keep depth and weight to a minimum.

Substrate green roof systems

This green roof system provides a depth of growing medium, usually around 80-200mm, to allow for the specification of a broader range of species and the planting schemes. The variety of options allows for an aesthetically pleasing layout plan to be created that can be of particular benefit if the roof is overlooked. The plants are generally low maintenance, and resistant to wind, frost, and drought.

On a flat roof, up to 5 degrees, the green roof build up comprises a protection layer atop the waterproofing, the BauderGREEN DSE 40 drainage board, filter layer, and substrate growing medium for the plants.

An extensive green roof can be created on a pitch of between 5 and 25 degrees and the BauderGREEN WSP reservoir board is specified as the water retention/drainage layer to enhance water storage for the plants, hold the substrate in place, and be sufficiently rigid to manage the imposed shear load.

Plus points

- Bauder vegetation options comprise seed mixes, plug plants, and sedum or wildflower blanket.
- Specification embraces all elements of the waterproofing, green roof components, and planting scheme.
- Cost effective on large roof areas.
- Single source for design of Bauder waterproofing and green roof with clear accountability.
- Comprehensive range of guarantee packages to fulfil cover requirements for the project (dependent on system/product selection). For more information contact our technical dept for a sample guarantee outlining cover level, terms and conditions.

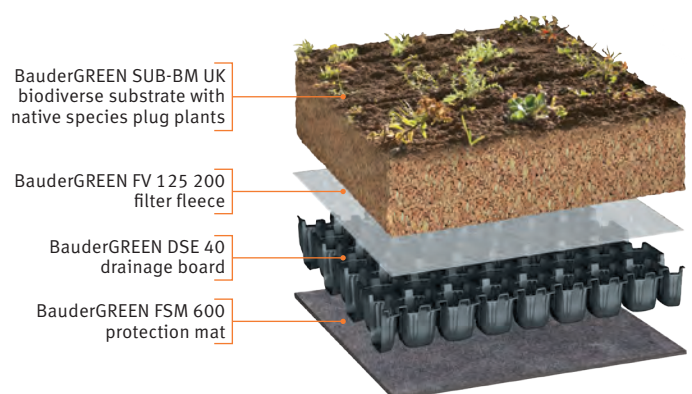

Bauder Extensive Green Roofs

Our vegetation options



BauderGREEN SB sedum blanket

This is a mature vegetation blanket, sown with a broad variety of drought and wind tolerant sedums on a coir carrier, that is 100% biodegradable, and typically grown for a year prior to harvesting and installation.

It is intended for application directly over BauderGREEN SUB-EM UK extensive substrate as the underlying growing medium.



BauderGREEN Plug Plants

Small seedling plants allows the specifier to select the individual sedum, grass, and wildflower species for the roof. These are individually hand planted according to the roof layout design and density of planting. If dense vegetation for roof coverage is desired then more plugs are specified per square metre.

We supply a large variety of plug plants to suit the specification and desired finish.



BauderGREEN Flora Seed Mixes

An economical and practical method of vegetating larger roof areas with plants establishing over an 18-24 month period, depending on the time of year sowing takes place and the weather conditions during the period of establishment.

Bauder Sedum System

All-in-one blanket system of mature sedum species, extensive substrate, and water retention and filter layer

This system has been developed for use directly over our waterproofing and is suitable for both new build construction and refurbishment projects.

The Bauder Sedum System is a versatile lightweight green roof solution that provides instant vegetation cover for the roof. The sedums are grown on a 'blanket' that is harvested like turf and rolled out on top of the waterproofing. The system can be installed on roofs up to 25 degrees when a retention strip is specified to stabilise the blankets on a slope.

Plus points

- Complete system for instant greening of a roof with mature sedum species.
- Most lightweight green roof of all our systems.
- Fire testing to BROOF(t4) for flat roofs and sloped roofs on specific Bauder waterproofing systems as verified by the BBA in our certification.
- Ideal for projects where there are weight, height, or cost constraints.
- Installed directly onto all types of our waterproofing.
- Comprehensive range of guarantee packages to fulfil cover requirements for the project (dependent on system/product selection). For more information contact our technical dept for a sample guarantee outlining cover level, terms and conditions.

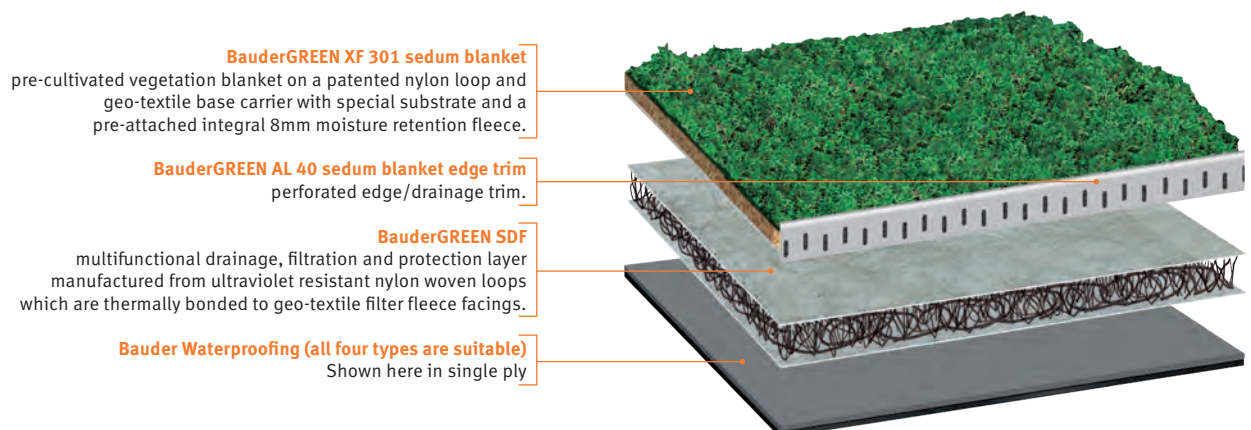

Bauder Sedum System



Chelsea Fotball Club Training Facility
London



BauderSOLAR G LIGHT

Biosolar PV system for renewable energy generation with a green roof and biodiverse vegetation

This is a unified solution for mounting solar PV arrays where the substrate and biodiverse vegetation provide the ballast to secure the array.

BauderSOLAR G LIGHT brings together net zero and environmental advantages to allow the entire roof area to qualify as a biodiverse green roof to meet planning and BREEAM requirements. Additionally, the biosolar solution increases the efficiency of the array because the vegetation preserves ambient rooftop temperatures, helping to keep solar modules at optimal output.

Supporting flora and fauna

The panels create a mixture of sunny, shaded, and sheltered zones to give a matrix of different habitats for a broader range of vegetation whilst also providing refuge areas for small invertebrates from inclement weather. Undulations in the substrate can be created to further enhance the diversity of flowering plants that then provides a rich foraging environment for bees and insects.

The substrate can be vegetated in several ways or combinations of planting schemes can be specified to create a variety of finishes. The BauderGREEN Flora 3 seed mix is a specific blend of low growing and shade tolerant native plants; plug plants can be used where specific species are required; and vegetation blankets provide instant coverage between the panels and stabilisation of the substrate in exposed locations.



Substrate depth variable depending on planting and ballast requirements

Shown here as an East-West orientation

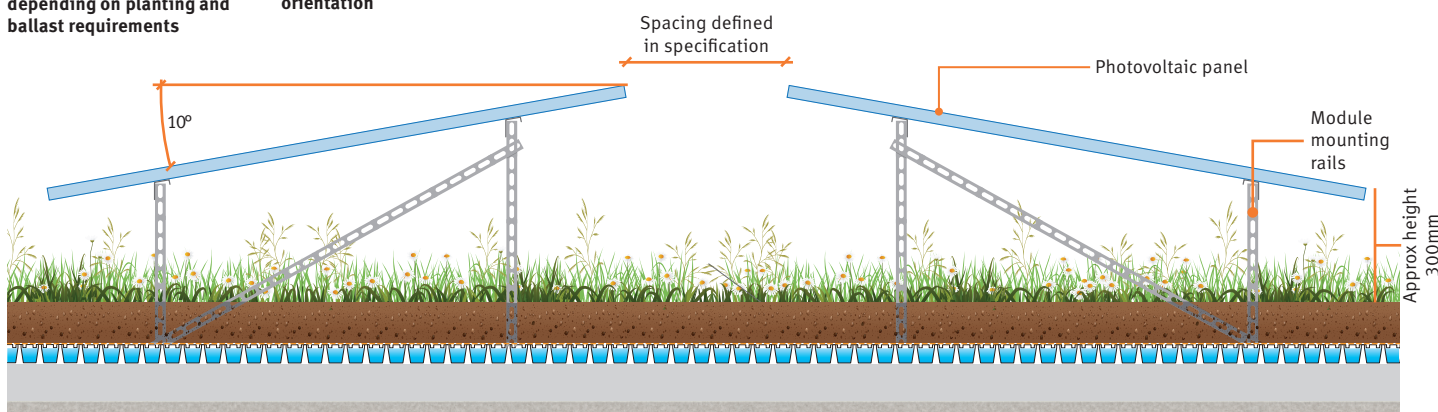



Noah's Ark Children's Hospice
Barnet

BUILDING BOARD

Roof Size:	5,100m ²
Specifier:	Squire and Partners
Approved Contractor:	Voland Roofing Limited
Green Roof Contractor:	Bridgeman & Bridgeman
PV Installer:	Joju Solar

Bauder Blue Roof System

Three systems for creating SuDS within a green roof depending on the finish and volume of water to be attenuated

Stormwater is attenuated for up to 48 hour period via a restrictive flow outlet that allows discharge rates to help prevent localised flooding.

BauderBLUE STORMsub System

This hybrid system utilises the water storage capacity of a green roof build up. The STORMsub system reduces the plastic content of the blue roof compared to a 100mm STORMcell system to enhance the environmental focus of the solution. The additional SUB-RE UK substrate layer and RE 40 drainage board act with the flow restrictor to carefully control the water discharge off the roof.

Finish options:

- Extensive and biodiverse vegetation

BauderBLUE STORMcell System

This high volume attenuation system creates a void space between the waterproofing and the surface finish. The void is created by the BauderGREEN RWR 100 and enables water movement to the flow restrictor outlet. The STORMcell system gives the greatest capacity for water storage, and if laid three layers thick the system will hold up to 285 litres of water per m².

Finish options:

- Extensive, biodiverse, and semi-intensive green roofs
- BauderSOLAR G LIGHT • Paving • Stone ballast

BauderBLUE STORMvoid System

This simple system creates a void space with Bauder pedestals and paving finish to an exact height to allow water movement to the flow restrictor outlet. Utilising Bauder pedestals ensures the entire system is covered by our guarantee.

Finish options:

- Paving • Metal decking

Plus points

- Our specification service will confirm suitability of Bauder waterproofing system and type of blue roof for each roof area.
- We provide technical calculations for the required discharge rate of the blue roof and its geographical location.

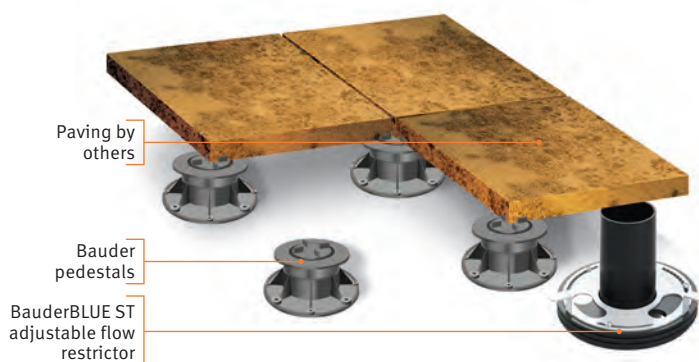
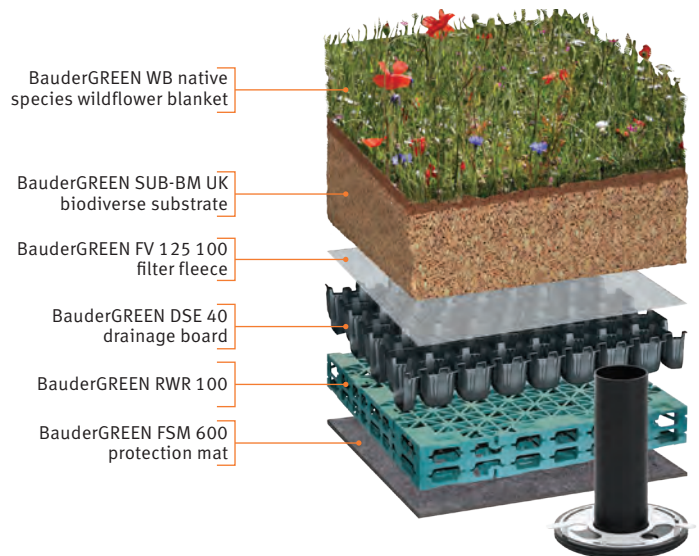
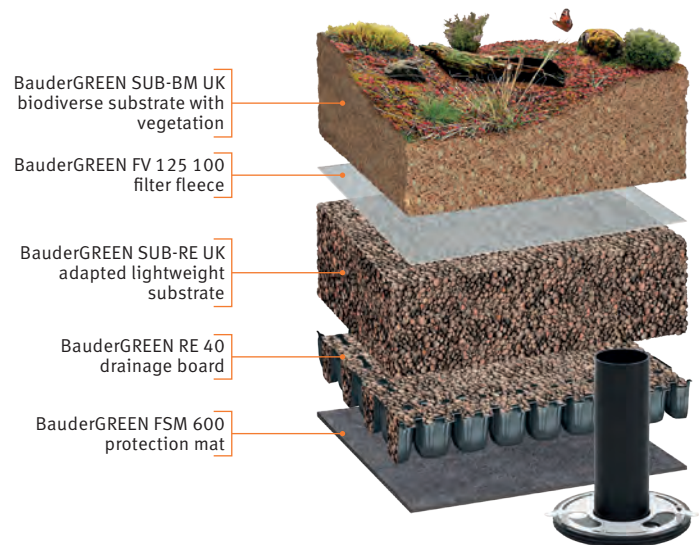

Bauder Blue Roof Systems

BauderBLUE STORMcell
High volume system with soft landscaping

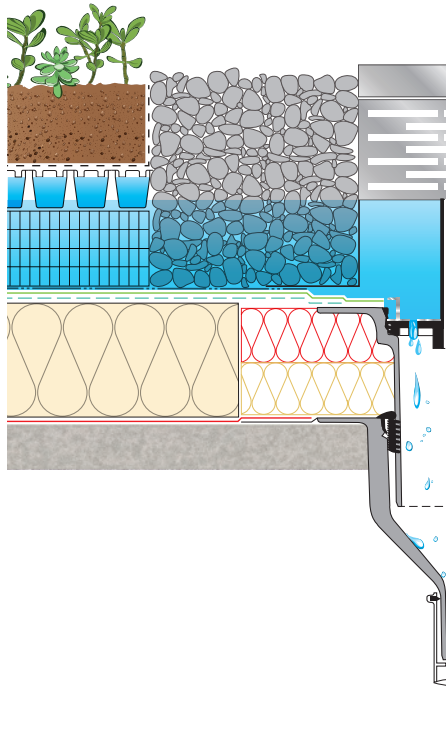

BauderBLUE STORMvoid
Medial solution with hard landscaping

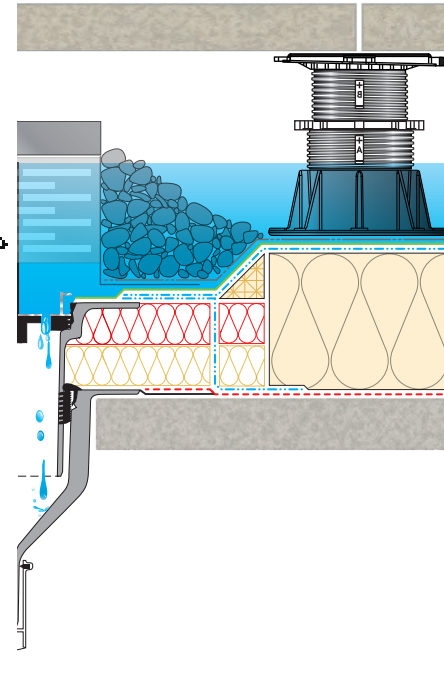

Biodiverse wildflower finish

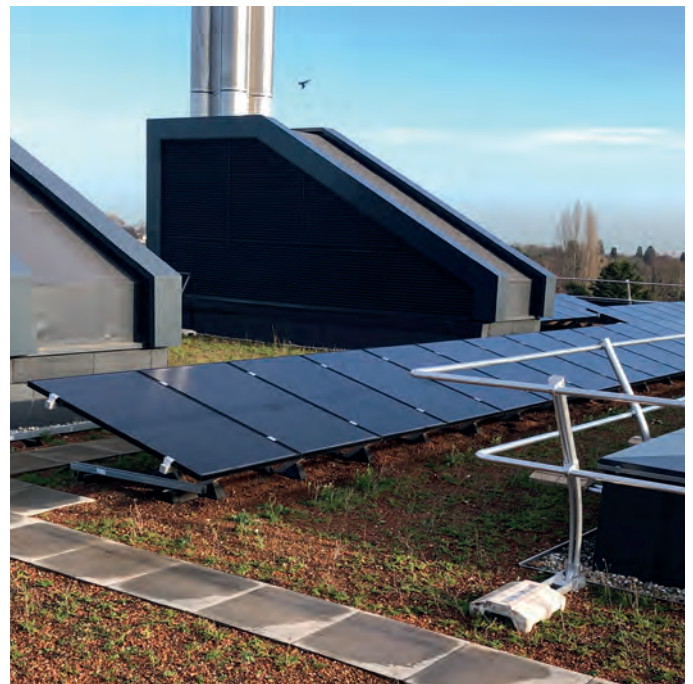

Waterproofing the Roof

Ensuring the building is watertight beneath a green roof

The waterproofing system is a key element in the success of a green roof and specific systems from our portfolio are suited to the different solutions.

Your area technical manager will work with you to ensure that the waterproofing system selected is suitable for the solution required for each roof area. Our systems are suitable for green roofs and FLL certified for root resistance.

Reinforced bitumen membrane systems

Noted for their lifespan and suitability for loads associated with green, blue, solar, and biosolar roofs as well as the increased access required for the maintenance of these facility roofs. The cap sheets incorporate a root inhibitor.

Waterproofing:

Bauder Total Green Roof System PLUS (BTGRS PLUS)
Bauder Total Green Roof System (BTGRS)
Bauderflex Green Roof System

Suitable for:

- Intensive, biodiverse, extensive, and sedum system green roofs.
- Blue roof systems for STORMsub, STORMcell, and STORMvoid.
- BauderSOLAR G LIGHT biosolar system.
- BauderSOLAR G LIGHT with BauderBLUE STORMcell blue roof.

Hot melt structural waterproofing

Cost-effective waterproofing specified primarily for new build construction of protected, inverted, or buried roofs such as podiums and plazas. The protection membrane includes a root inhibitor.

Waterproofing:

Bauder Hot Melt System

Suitable for:

- Intensive, biodiverse, extensive, and sedum system green roofs.
- Blue roof systems for STORMsub, STORMcell, and STORMvoid.
- BauderSOLAR G LIGHT biosolar system.
- BauderSOLAR G LIGHT with BauderBLUE STORMcell blue roof.

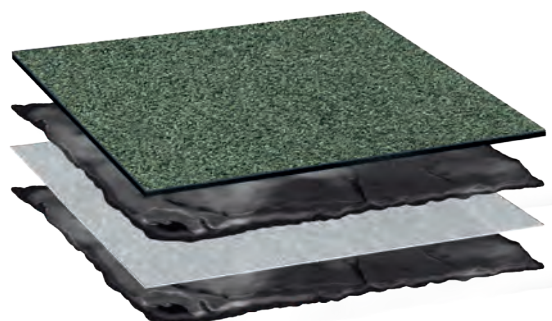
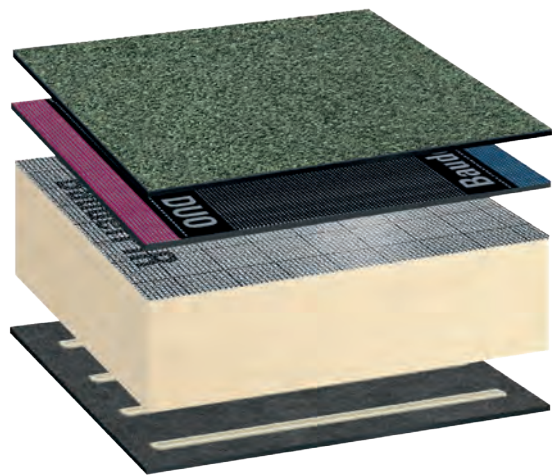

Single ply systems

Lightweight and advantageous if the project has load bearing considerations. If a green roof is specified, the membranes installed are a minimum 1.5mm thick for FLL certification.

Waterproofing:

Bauder Thermofol System
Bauder Thermoplan System

Suitable for:

- Biodiverse, extensive, and our sedum system green roofs.
- BauderSOLAR G LIGHT biosolar system.

Cold applied liquid systems

Flexible, seamless waterproofing that fully bonds to the substrate and easily forms around complex detailing and in constrained areas of access. The systems are inherently root resistant.

Waterproofing:

Bauder LiquiTEC Roof System

Suitable for:

- Biodiverse, extensive, and our sedum system green roofs.

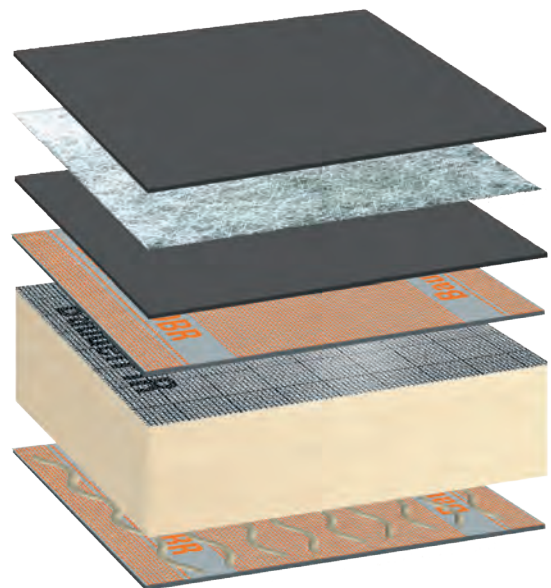



East Anglian Children's Hospice
Ipswich

BUILDING BOARD

Roof Size: 700m²

Root Systems: Bauder Total Green Roof System
and Plug Plants

Architect: Barefoot & Gilles

Technical Support Service for Green Roofs

Supporting you in the design of a green roof to meet project requirements and budget

Our technical managers are based nationwide and play a vital role in the success of every project from conceptual stage through to hand-over and sign-off of the Bauder installation.

We assist you with the design of the detailing, writing the specification for the flat roof solution, and recommend suitable approved contractors to tender for the project. Our service is without charge, and we work with you to ensure your roof specification meets all your needs.

Working with you to understand

- What is required on the roof.
- Landscape finish to be achieved.
- Levels of access required.
- Waterproofing system requirements.
- Planning constraints and conditions.
- Project location, climate, and roof size.
- Levels of rainwater retention or irrigation requirements.
- Drainage for the roof.
- Budget.

Our service to you delivers

- Proposed waterproofing system.
- Combination of green roof components for water storage, drainage, and protection layers.
- Substrate requirements and depth.
- Vegetation proposal and planting scheme.
- Irrigation requirement.
- Weight loading of the solution.
- Wind uplift resolutions.
- Green or blue roof integration and vegetation scheme for BauderSOLAR G LIGHT system.
- Comprehensive range of guarantee packages to suit project and cover requirements.



Project Study

Lagg Distillery, Isle of Arran

Bauder Sedum System with BauderGREEN XF 301 sedum blanket.

Synopsis

New build whisky distillery constructed with a metal roof deck laid on steelwork incorporating a warm roof build-up with a lightweight sedum green roof finish to resonate with the landscape and withstand the prevailing winds.

The client wanted to create an iconic landmark with a roofscape that would echo the contours of Arran. To ensure all expectations were met, Bauder worked closely with the architect, Denham Youd, during the design and specification of the project.

The challenge

Complex roof shapes rising from 2 meters above ground level to 12 meters and gradients ranging from 8 degrees to 31 degrees. On the steeply pitched roofs, the system was supported by mechanically fixed battens to carry the weight over the extreme slopes.

The building is perched on cliffs close to the Atlantic Ocean which face prolonged storms and gale force winds for many weeks a year. A sedum restraint system consisting of stainless steel retention strips and aluminium edge trims hold the vegetation blanket in place and prevent wind uplift and slippage.

Advocacy

Scott Dean, managing director at Greenroof UK Ltd:

“This project pushed the boundaries in terms of installation, logistics, and environment; therefore, it is a tremendous accolade to have won an award that acknowledges the contribution of everyone involved.”

Systems summary

Waterproofing	Bauder Total Green Roof System
Green roof	Bauder Sedum System



Highlights

- Complex steep roof shapes.
- Delivery of materials and equipment highly dependant on ferry crossings to Isle of Arran.
- Fall arrest system installed for maintenance access.
- Award winning project.



Lagg Distillery
Isle of Arran

BUILDING BOARD

Roof Size:	2,700m ²
Roof Systems:	Bauder Total Green Roof System Bauder Sedum System
Client:	Isle of Arran Distillery
Specifier:	Denham Youd
Building Contractor:	BHC Limited
Approved Contractor:	Green Roof Limited

Project Study

Fulham Jetty, London

Biodiverse green roof.

Synopsis

In this landmark regeneration scheme of an abandoned jetty at Fulham Wharf, the client was eager to reconnect the jetty to the shore with a new single storey ecological education centre for the local community and a biodiverse wildlife reserve on the roof.

The challenge

The building's new roof swoops down to become a continuum with the jetty deck and is covered with a green habitat providing three distinct environments for wildlife. The complex roof design incorporates different waterproofing and green roof finishes including a central sloped section.

Since its official opening, the lower wildflower roof has become a haven for a variety of different birds and insects.

Systems summary

Waterproofing	Bauder Total Green Roof System on sloped and upper roof Bauder Hot Melt on lower roof
Green roofs	BauderGREEN SB and Bauder Sedum System BauderGREEN WB wildflower blanket

Highlights

- Full technical input and support to ensure the specification for differing habitats on the distinct roof areas would be successful.
- Special timber design for retaining the substrate and vegetation blankets.
- Bauder elements covered in a single guarantee.





Fulham Jetty
London

BUILDING BOARD

Roof Size:	1,000m ²
Clients:	Thames Explorer Trust and Hammersmith and Fulham Urban Studies Centre
Specifier:	Fabrik
Approved Contractor:	Accurate Roofing Limited

Project Study

Small Animal Hospital, University of Glasgow

Intensive green roof.

Synopsis

Set within the Garscube Estate, the hospital forms part of the University of Glasgow's faculty of veterinary medicine. The new build construction was designed with as minimal visual impact as possible, so the building was constructed within the side of a hill with a green roof.

The challenge

Traditionally, the open texture substrates can allow the seed to be blown off the roof and to migrate down into the growing medium to a point where it cannot germinate properly, creating a patchy finish. To prevent this, Our specialist seed bed substrate mix was used as a topdressing over intensive substrate, allowing the use of a grass seed mix that could easily grow and blend with the surrounding grassland.

Systems summary

Waterproofing Bauder Total Green Roof System
Green roof Grass seed mix

Highlights

- Full technical input and support.
- Bespoke solution for substrate.
- Comprehensive guarantee package for complete Bauder solution.



BUILDING BOARD

Roof Size:	2,800m ²
Client:	University of Glasgow
Approved Contractor:	Advanced Roofing Systems

Project Study

Department of Engineering, Cambridge University

Bauder extensive green roof and BauderSOLAR G LIGHT with BauderBLUE STORMcell.

Synopsis

This new build project in the centre of Cambridge combines a sustainable urban drainage solution (SuDS) with vegetation and renewable energy on a warm roof construction.

The client identified sustainability as being a key driver in the design of the roof, but also sought a single source supplier that could provide a guarantee for both workmanship and products. The Bauder team created the solution bringing together the entire roof requirement for a single guarantee.

The challenge

The roof deck was constructed using a pretensioned concrete plank roof structure. Due to the large span of these planks, the dead load weight to the roof was restricted requiring a measured approach to the design of the solar PV, green, and blue roof.

To achieve the flat deck, with no backfalls, the final deflection of the fully loaded roof was calculated and the concrete deck was screeded to give a flat finish.

Systems summary

Solar PV	BauderSOLAR G LIGHT
Waterproofing	Bauder Total Green Roof System
Green roof	Bauder biodiverse substrate with native species vegetation and drip-line irrigation
Blue roof	BauderBLUE STORMcell discharge rate 0.77 litres/second

Highlights

- Deck deflection calculated and screed finish ensured compliance to BS 6229:2018.
- Warm roof with 160mm BauderPIR FA-TE insulation.
- Unified approach to design of the solution.
- Full Bauder support for technical advice, design, installation monitoring and inspections.



BUILDING BOARD

Roof Size:	1,610m ²
Client:	University of Cambridge
Specifier:	RH Partnership Architects
Main Contractor:	SDC Limited
Approved Contractor:	Voland Limited

UNITED KINGDOM

Bauder Limited
70 Landseer Road, Ipswich, Suffolk
IP3 0DH, England
T: +44 (0)1473 257671
E: info@bauder.co.uk
bauder.co.uk

IRELAND

Bauder Limited
O'Duffy Centre, Carrickmacross,
Co. Monaghan, Ireland
T: +353 (0)42 9692 333
E: info@bauder.ie
bauder.ie

Respecting the planet

Reducing use of materials



This literature is only available as a digital brochure to reduce the use of paper. If you need to print it, please recycle at the end of purposeful use.